

BEFORE YOU BEGIN

Please check to ensure you have all of the below items before you begin installation of your product.

- Acoustical Clouds (quantities and sizes based on your order.)
- Mounting Hardware (Rotofast Included with order. Quantities vary based on size of cloud.)

Fiberglass Rotofast Cloud Anchor

	Number of Anchors (Based on Panel Size)							
	24" x 24"	36" x 24"	36" x 36"	48" x 12"	48" x 24"	48" x 36"	48" x 48"	
60" x 24"	60" x 36"	60" x 48"						
72" x 24"	72" x 36"	72" x 48"	96" x 24"	96" x 36"			6 Anchors	
96" x 48"	120" x 24"	120" x 36"	120" x 48"					
							8 Anchors	

IF YOU ARE MISSING ANY REQUIRED ITEMS FROM YOUR ORDER,
PLEASE CONTACT US ONLINE [HERE](#).

Mounting Method: Fiberglass Rotofast Cloud Anchor

STEP 1

Secure the ceiling mount eye hooks (or alternative mounting hardware as specified) into the ceiling substrate.

STEP 2

Secure suspension wire to the cloud anchors (located on the back of the acoustic cloud) and to the hardware installed in the ceiling substrate.

See [Appendix A](#) for suggested Rotofast install locations based on your cloud size.

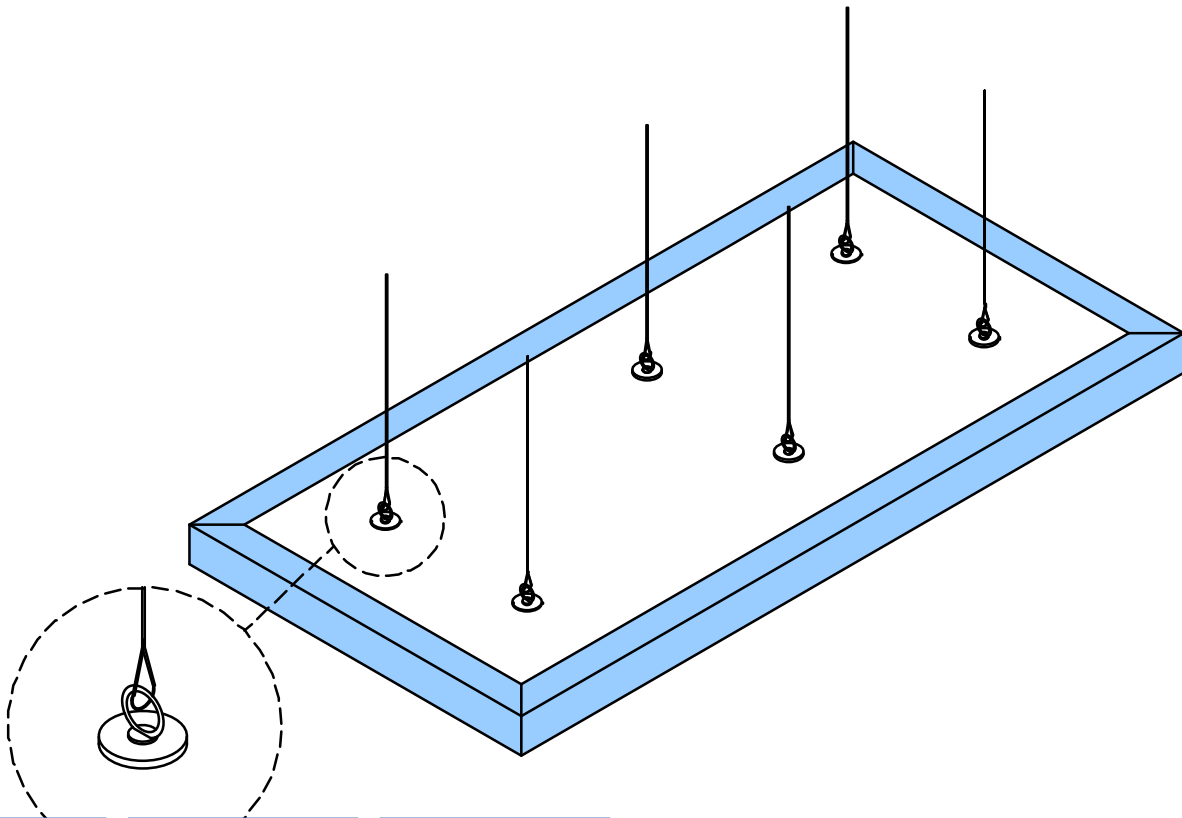

BEFORE YOU BEGIN

Please check to ensure you have all of the below items before you begin installation of your product.

- Acoustical Clouds with Polyester Core (quantities and sizes based on your order)
- Mounting Cables (purchased separately)
- Mounting Hardware (Rotofast Polyester Cloud Anchors included with order. Quantities vary based on size of cloud.)
- Utility knife with sharp blade (purchased separately)



Polyester Rotofast Cloud Anchor

	Number of Anchors (Based on Panel Size)							
	24" x 24"	36" x 24"	36" x 36"	48" x 12"	48" x 24"	48" x 36"	48" x 48"	
60" x 24"	60" x 36"	60" x 48"						
72" x 24"	72" x 36"	72" x 48"	96" x 24"	96" x 36"			6 Anchors	
96" x 48"	120" x 24"	120" x 36"	120" x 48"				8 Anchors	

Note: Adjustable ceiling cloud hanging wire and ceiling-side attachment hardware are not included.

IF YOU ARE MISSING ANY REQUIRED ITEMS FROM YOUR ORDER,
PLEASE CONTACT US ONLINE [HERE](#).

Mounting Method: Rotofast Cloud Anchor

STEP 1

Secure the ceiling mount eye hooks (or alternative mounting hardware as specified) into the ceiling substrate.

STEP 2

Set your utility knife to 3/4". Make a cut approximately 1-1/2" long by 3/4" deep at each anchor location.

STEP 3

Align the leading edge of the anchor with the cut. Insert the leading edge into the cut, apply firm pressure and turn the anchor clock-wise. As you turn the cloud anchor will tighten. Do not overtighten but continue to apply firm pressure until cloud anchor is completely installed.

STEP 4

Attach your preferred hanging hardware.

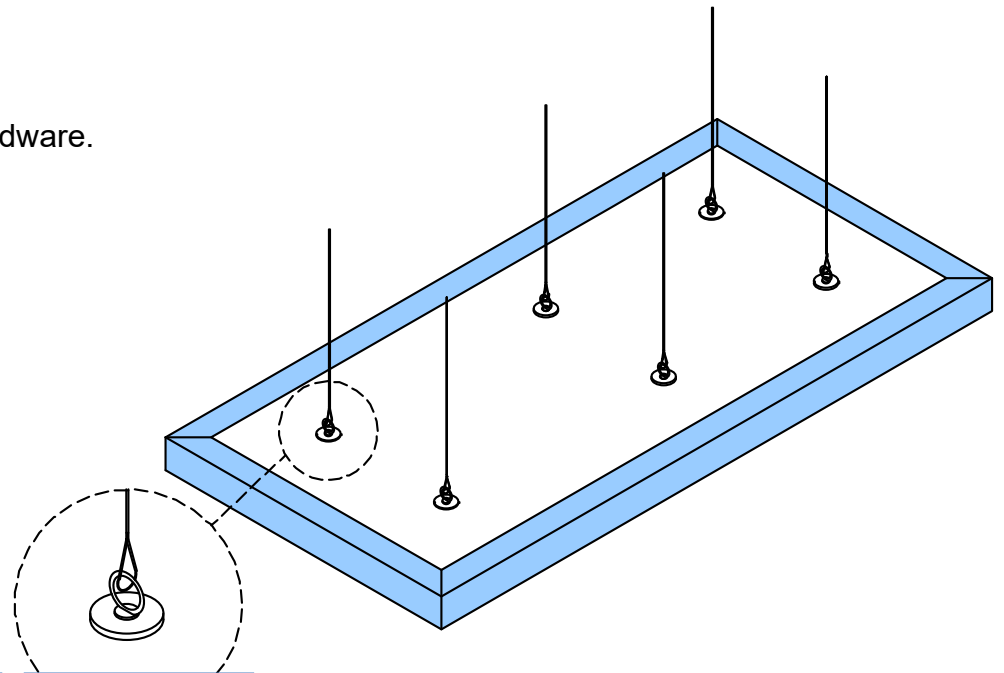



Rotofast Polyester Cloud Anchor Leading Edge



Cut polyester with a sharp utility knife



Install cloud anchor into the cut



Attach cloud anchor to hanging hardware



Installed Rotofast Polyester Cloud Anchors

VISIT rotofast.com/polyester-panel-anchor/
FOR DETAILED VIDEO INSTRUCTIONS

Appendix A: Fiberglass and Polyester Rotofast Anchor Locations

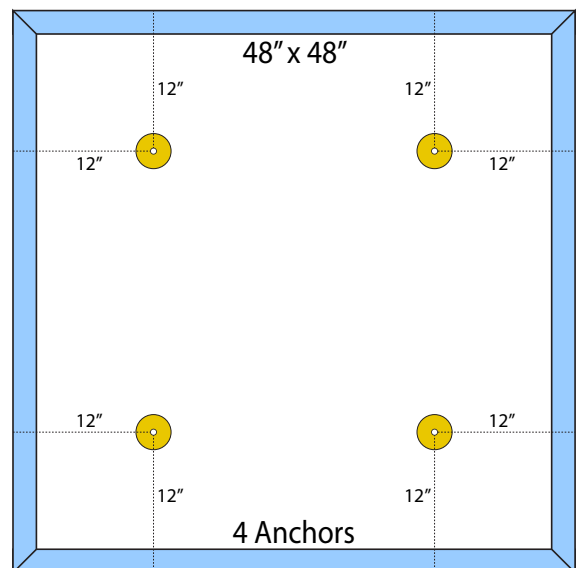
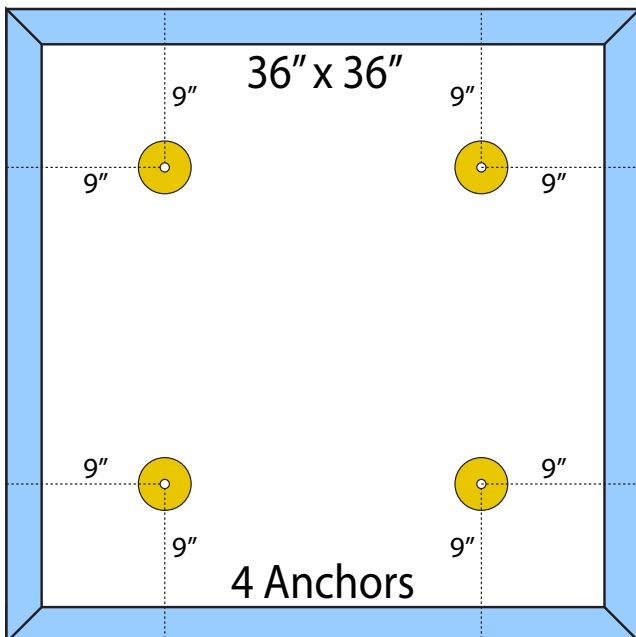
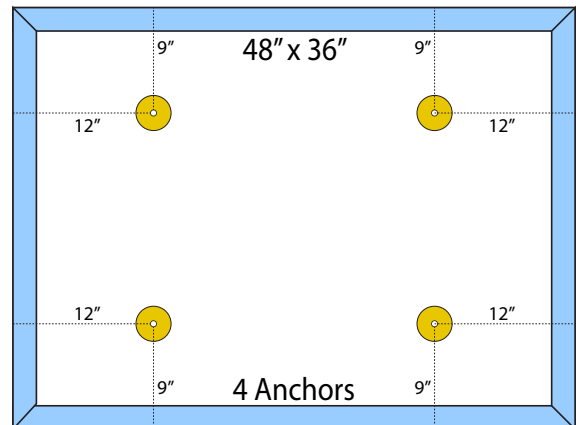
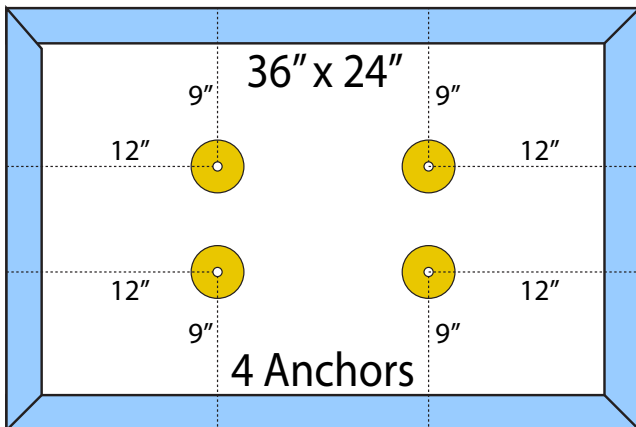
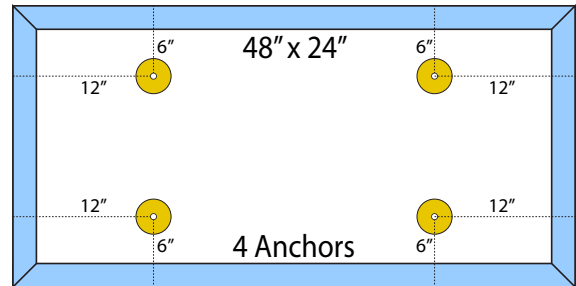
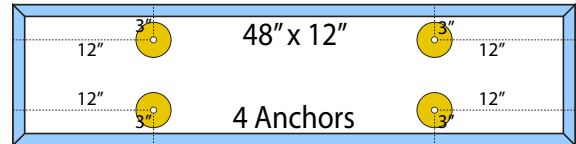
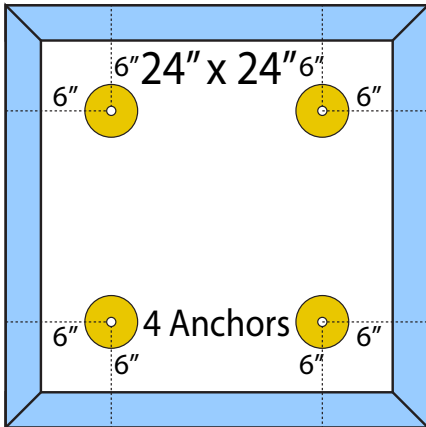

Appendix A: Fiberglass and Polyester Rotofast Anchor Locations

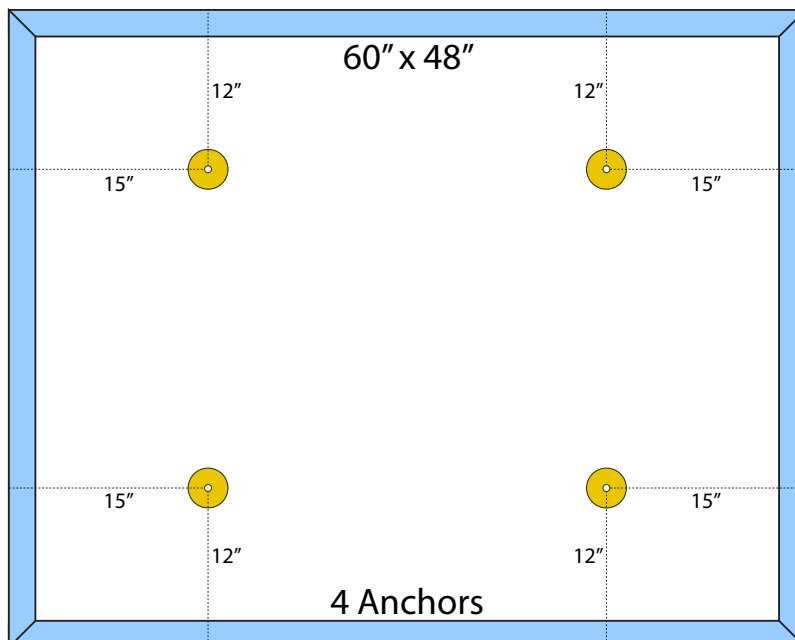
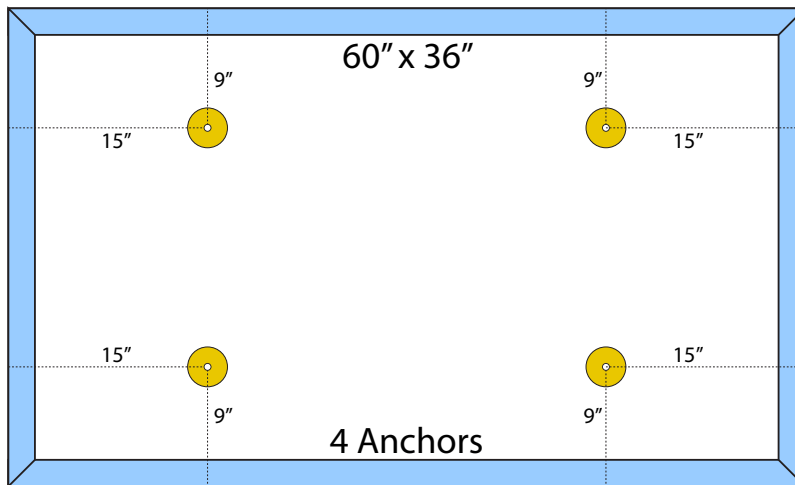
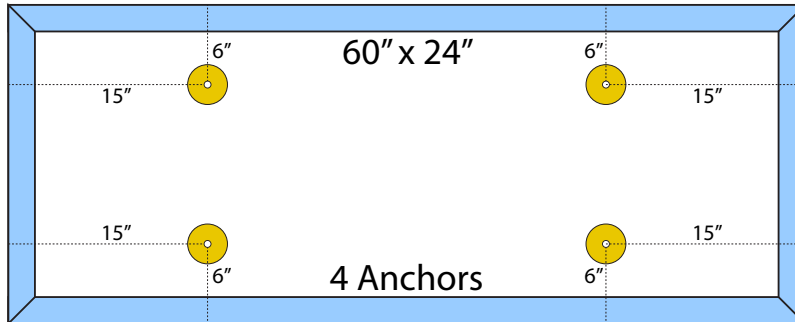

Appendix A: Fiberglass and Polyester Rotofast Anchor Locations

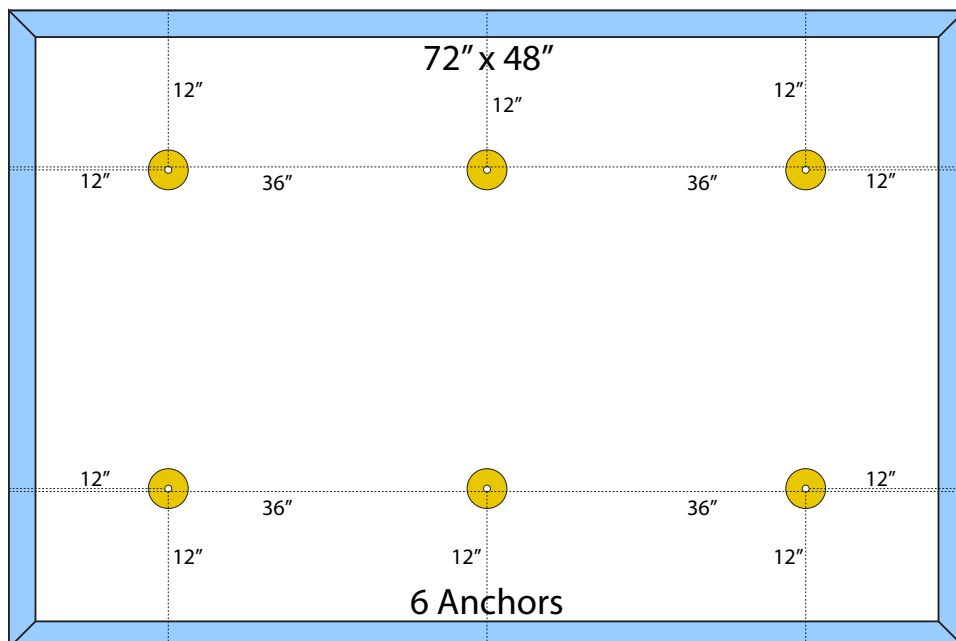
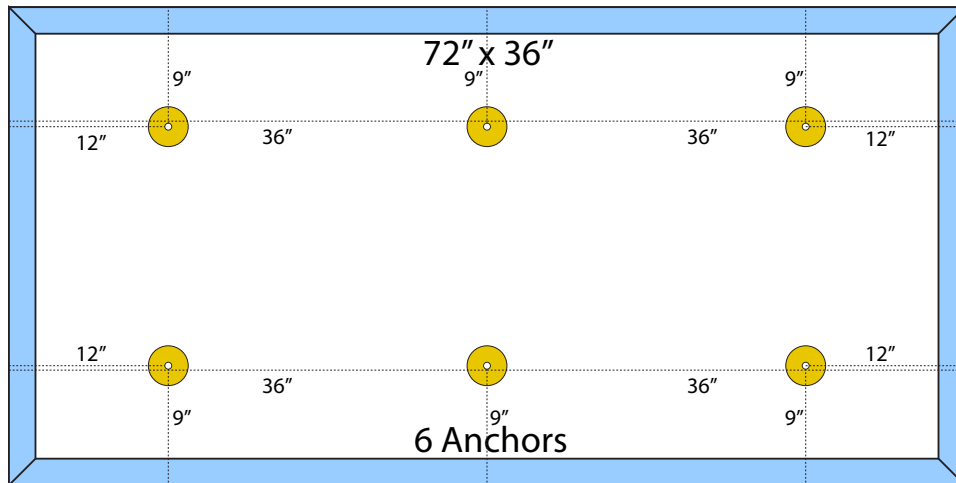
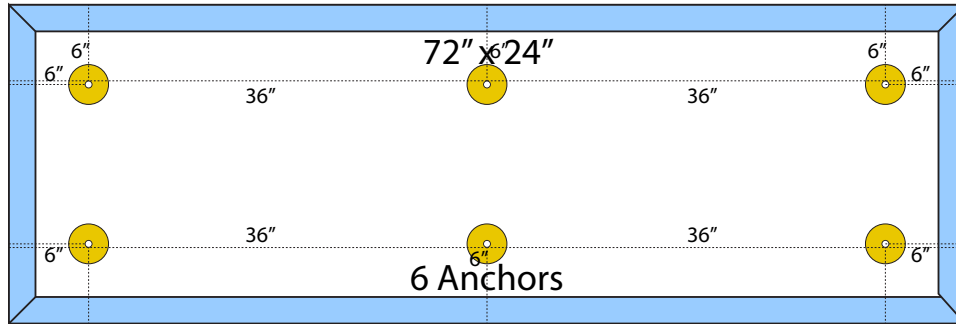

Appendix A: Fiberglass and Polyester Rotofast Anchor Locations

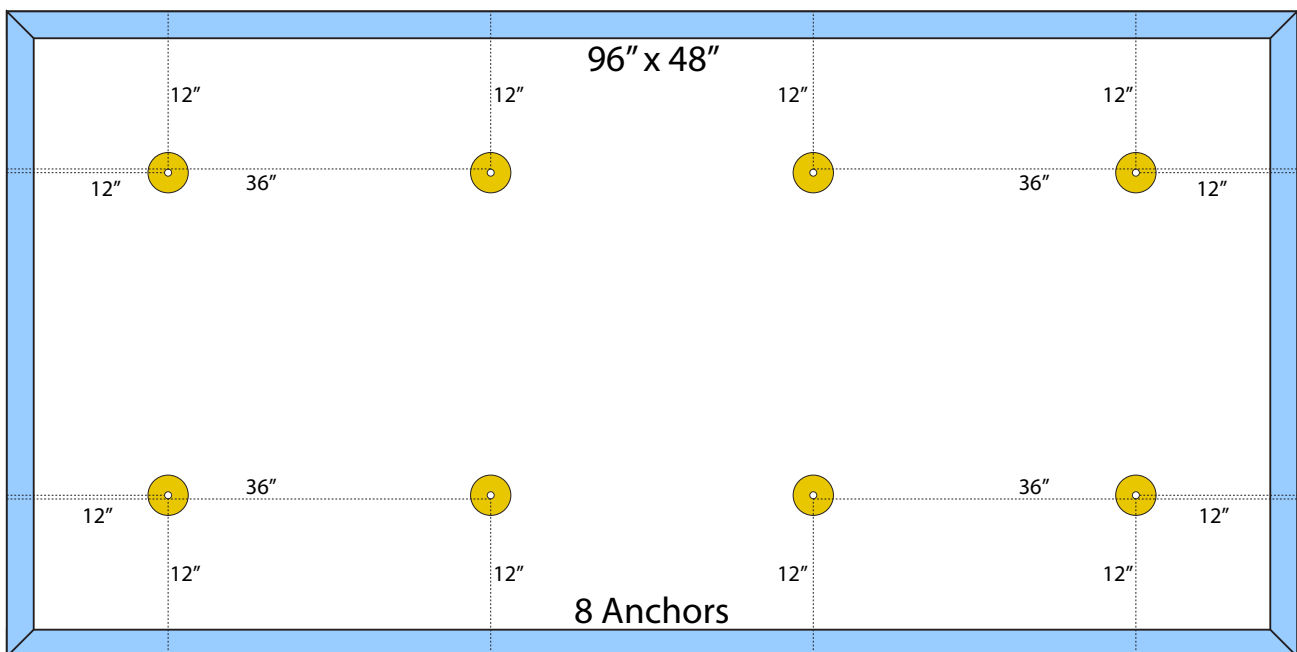
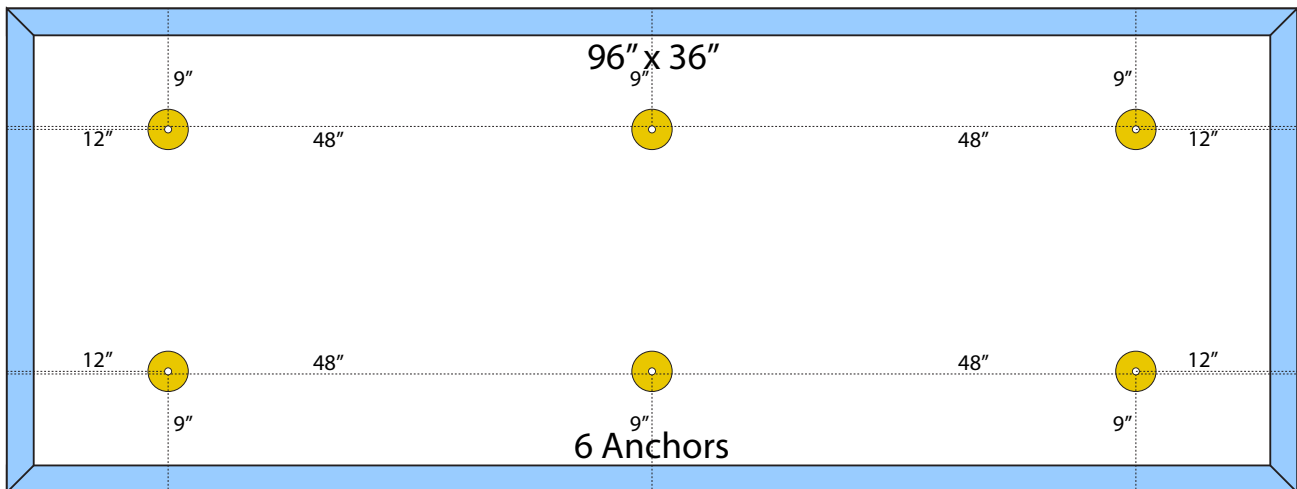
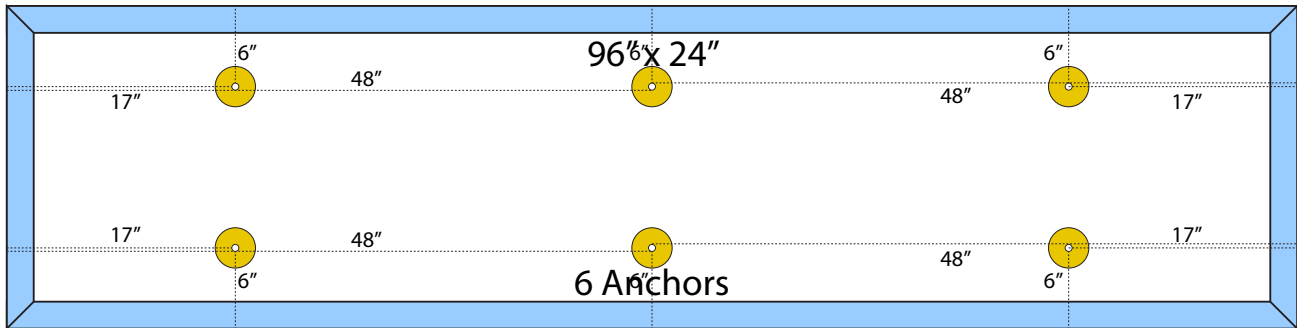

Appendix A: Fiberglass and Polyester Rotofast Anchor Locations

