

### BEFORE YOU BEGIN

Please check to ensure you have all of the below items before you begin installation of your product.

- Acoustical Clouds (quantities and sizes based on your order.)
- Mounting Hardware (Rotofast Included with order. Quantities vary based on size of cloud.)

#### Fiberglass Rotofast Cloud Anchor

	Number of Anchors (Based on Panel Size)							4 Anchors
	24" x 24"	36" x 24"	36" x 36"	48" x 12"	48" x 24"	48" x 36"	48" x 48"	
	60" x 24"	60" x 36"	60" x 48"					
	72" x 24"	72" x 36"	72" x 48"	96" x 24"	96" x 36"			
	96" x 48"	120" x 24"	120" x 36"	120" x 48"			8 Anchors	

IF YOU ARE MISSING ANY REQUIRED ITEMS FROM YOUR ORDER,  
PLEASE CONTACT US ONLINE [HERE](#).

# Mounting Method: Fiberglass Rotofast Cloud Anchor

## STEP 1

Secure the ceiling mount eye hooks (or alternative mounting hardware as specified) into the ceiling substrate.

## STEP 2

Secure suspension wire to the cloud anchors (located on the back of the acoustic cloud) and to the hardware installed in the ceiling substrate.

See [Appendix A](#) for suggested Rotofast install locations based on your cloud size.

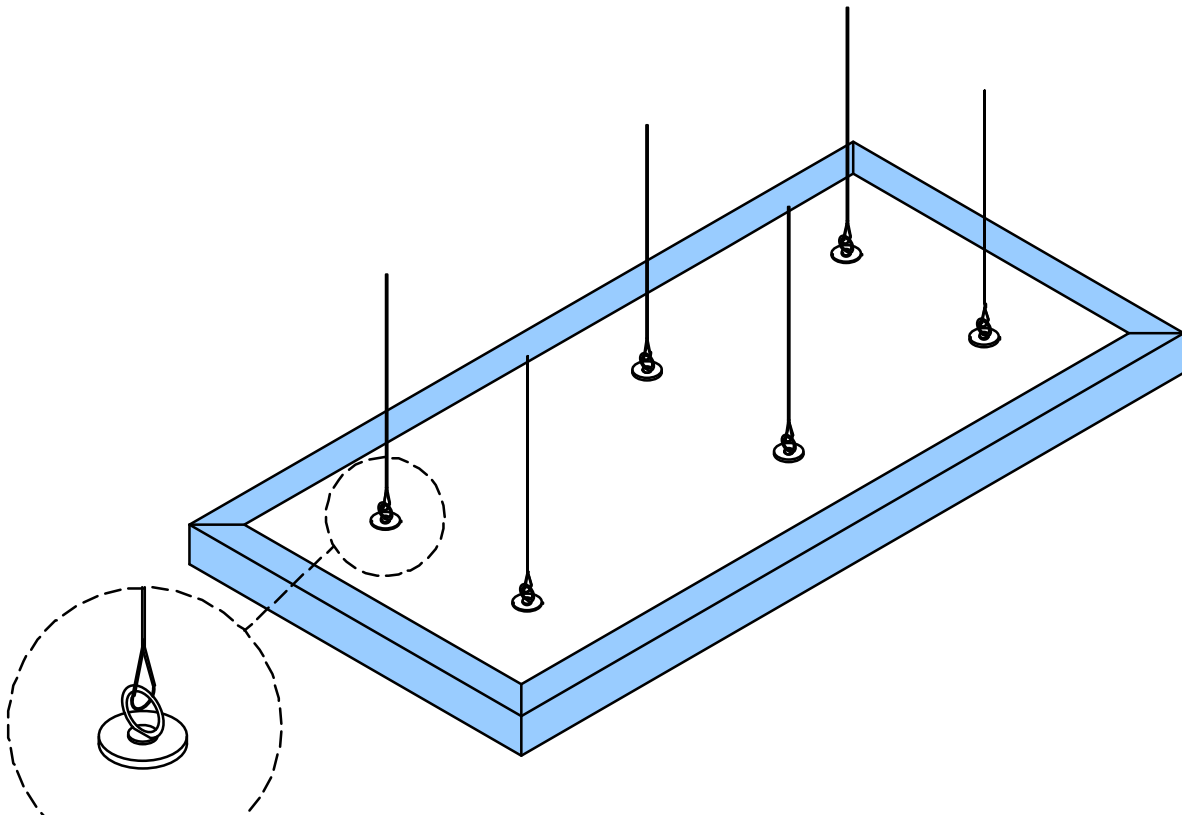

### BEFORE YOU BEGIN

Please check to ensure you have all of the below items before you begin installation of your product.

- Acoustical Clouds with Polyester Core (quantities and sizes based on your order)
- Mounting Cables (purchased separately)
- Mounting Hardware (Rotofast Polyester Cloud Anchors included with order. Quantities vary based on size of cloud.)
- Utility knife with sharp blade (purchased separately)



#### Polyester Rotofast Cloud Anchor

	Number of Anchors (Based on Panel Size)							
	24" x 24"	36" x 24"	36" x 36"	48" x 12"	48" x 24"	48" x 36"	48" x 48"	
60" x 24"	60" x 36"	60" x 48"						
	72" x 24"	72" x 36"	72" x 48"	96" x 24"	96" x 36"			6 Anchors
	96" x 48"	120" x 24"	120" x 36"	120" x 48"				8 Anchors

**Note:** Adjustable ceiling cloud hanging wire and ceiling-side attachment hardware are not included.

IF YOU ARE MISSING ANY REQUIRED ITEMS FROM YOUR ORDER,  
PLEASE CONTACT US ONLINE [HERE](#).

---

---

## Mounting Method: Rotofast Cloud Anchor

### STEP 1

Secure the ceiling mount eye hooks (or alternative mounting hardware as specified) into the ceiling substrate.

### STEP 2

Set your utility knife to 3/4". Make a cut approximately 1-1/2" long by 3/4" deep at each anchor location.

### STEP 3

Align the leading edge of the anchor with the cut. Insert the leading edge into the cut, apply firm pressure and turn the anchor clock-wise. As you turn the cloud anchor will tighten. Do not overtighten but continue to apply firm pressure until cloud anchor is completely installed.

### STEP 4

Attach your preferred hanging hardware.

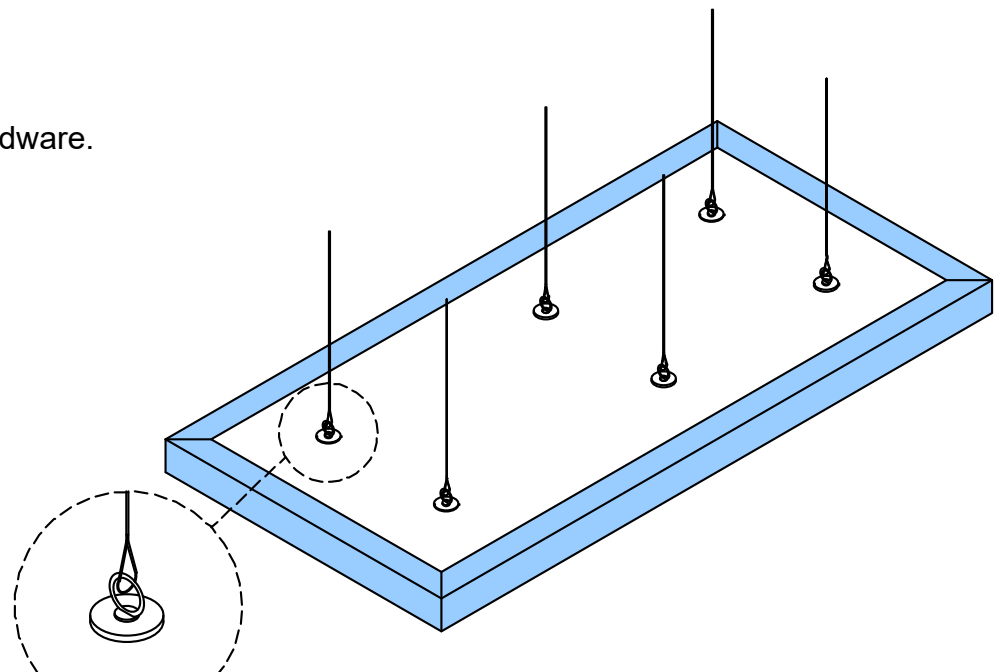



Rotofast Polyester Cloud Anchor Leading Edge



Cut polyester with a sharp utility knife



Install cloud anchor into the cut



Attach cloud anchor to hanging hardware



Installed Rotofast Polyester Cloud Anchors

VISIT [rotofast.com/polyester-panel-anchor/](https://rotofast.com/polyester-panel-anchor/)  
FOR DETAILED VIDEO INSTRUCTIONS

**Appendix A: Fiberglass and Polyester  
Rotofast Anchor Locations**

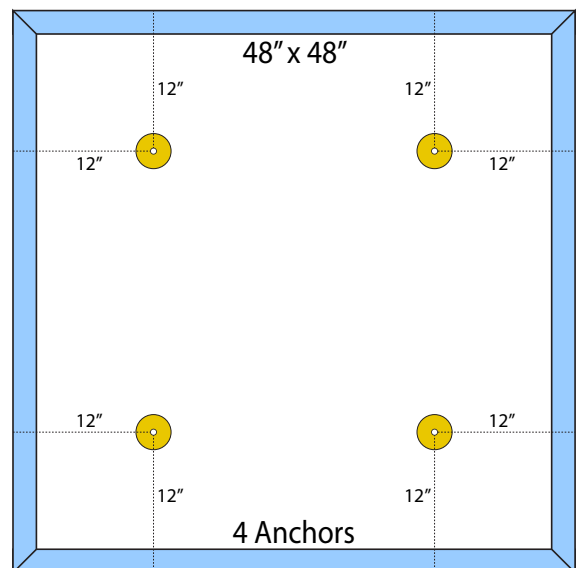
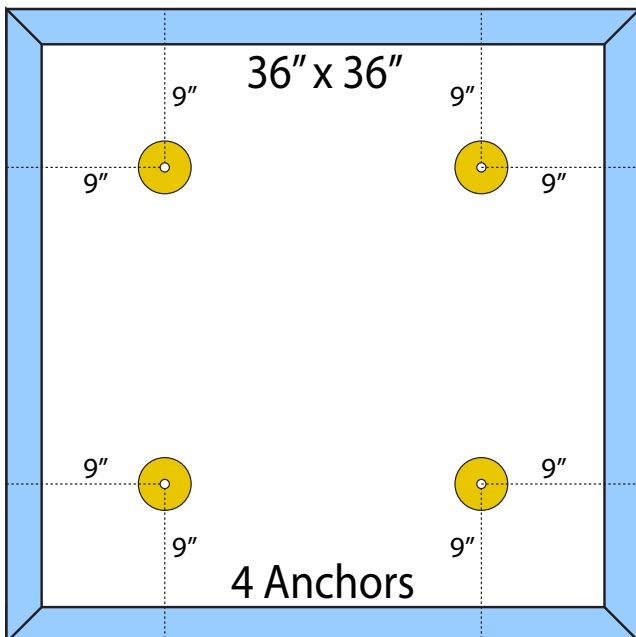
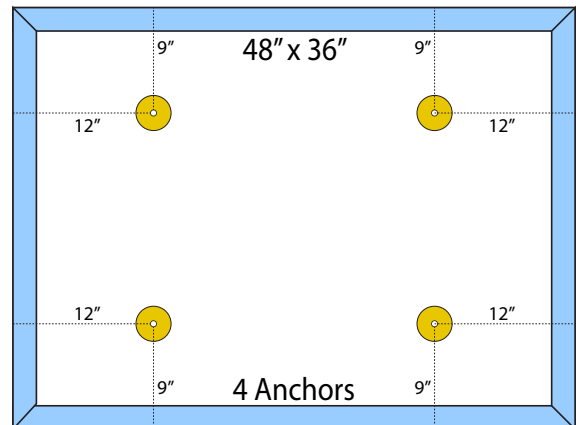
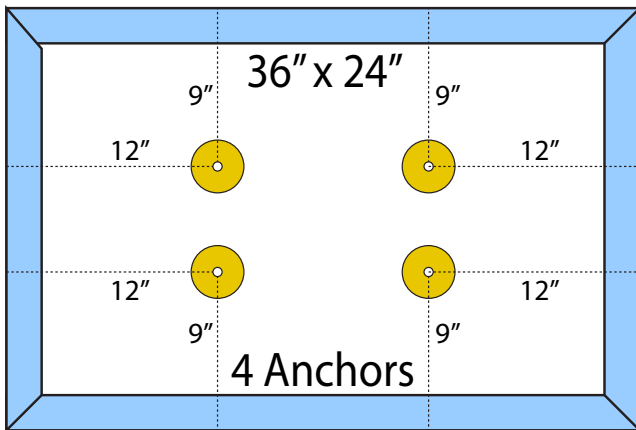
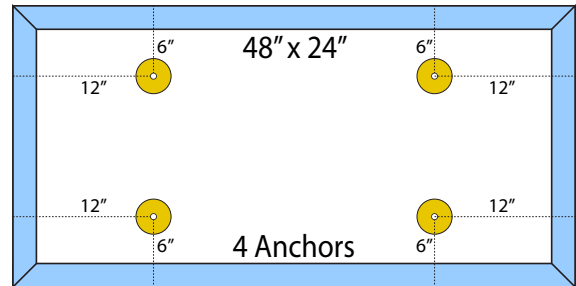
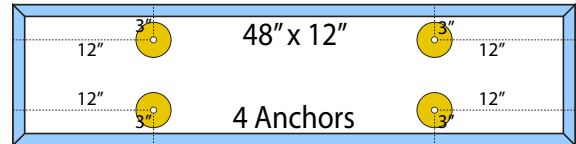
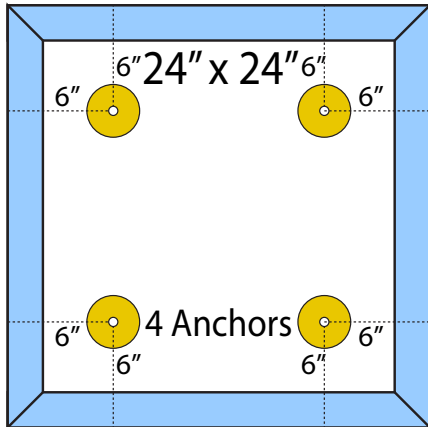

## Appendix A: Fiberglass and Polyester Rotofast Anchor Locations

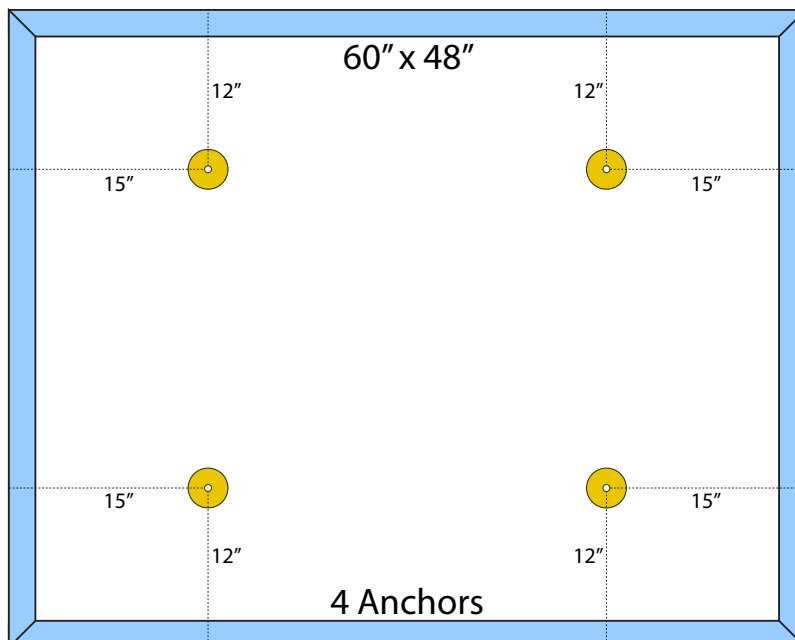
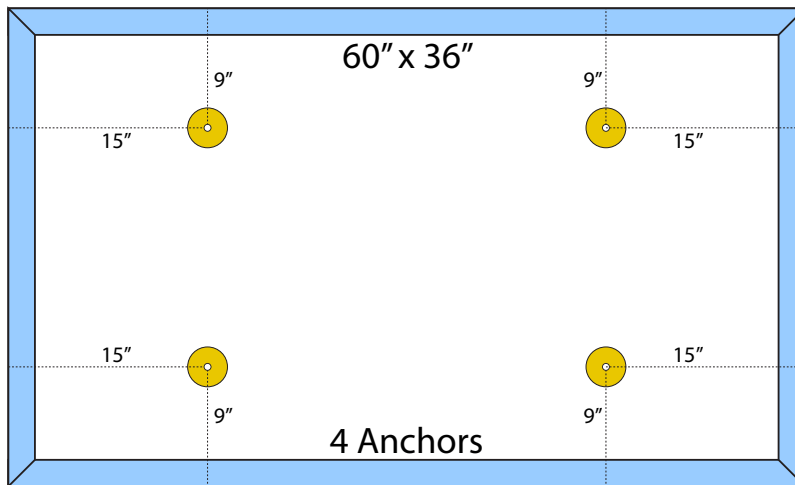
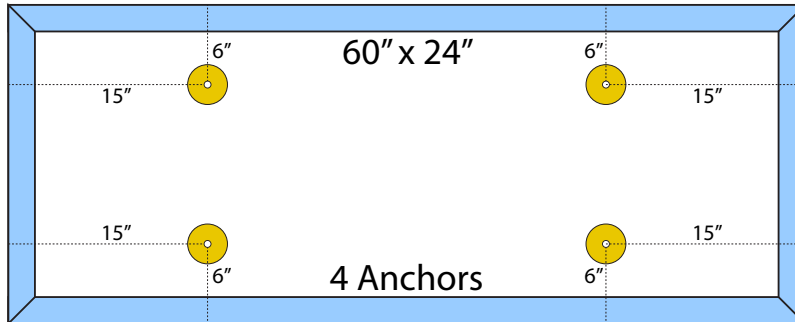

## Appendix A: Fiberglass and Polyester Rotofast Anchor Locations

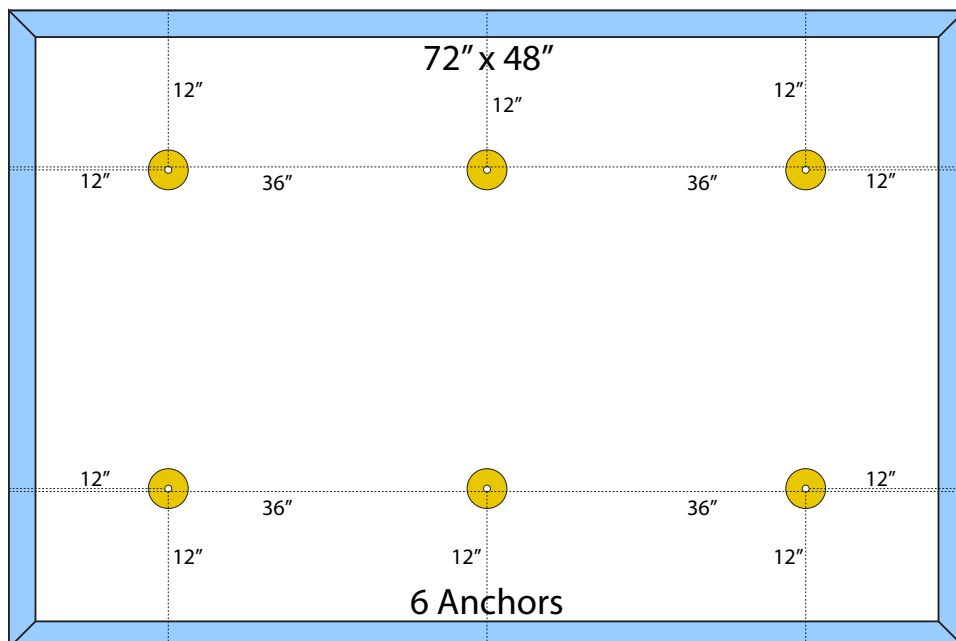
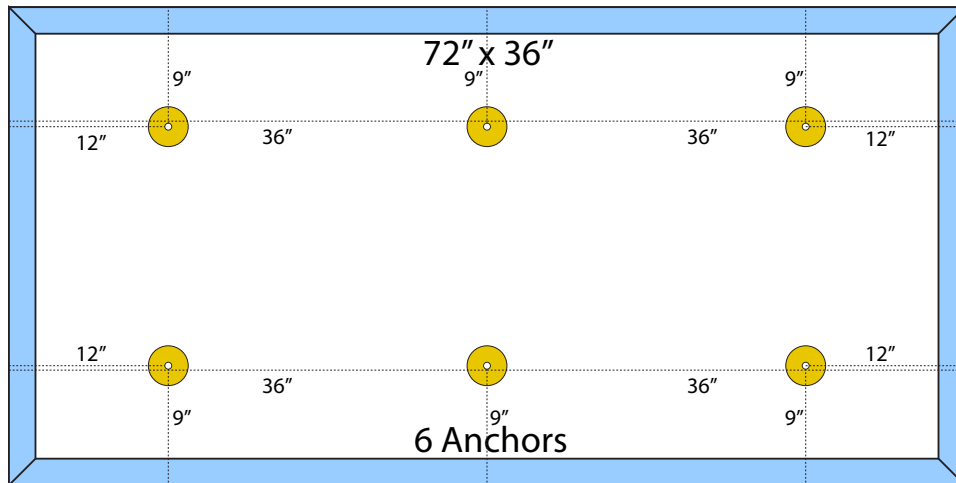
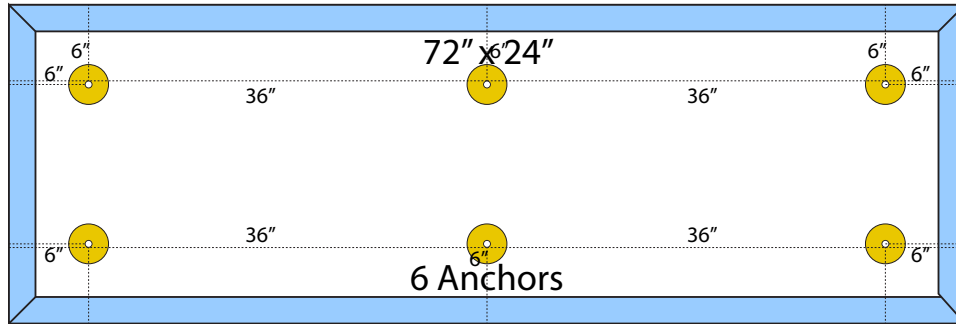

## Appendix A: Fiberglass and Polyester Rotofast Anchor Locations

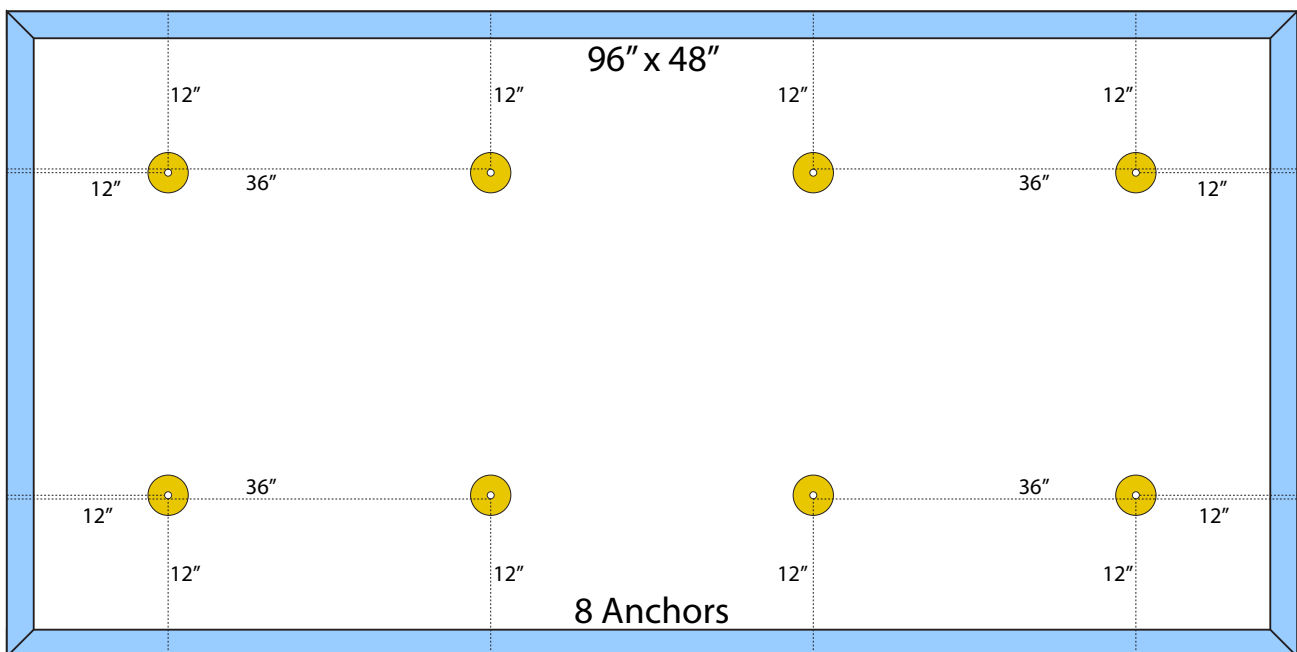
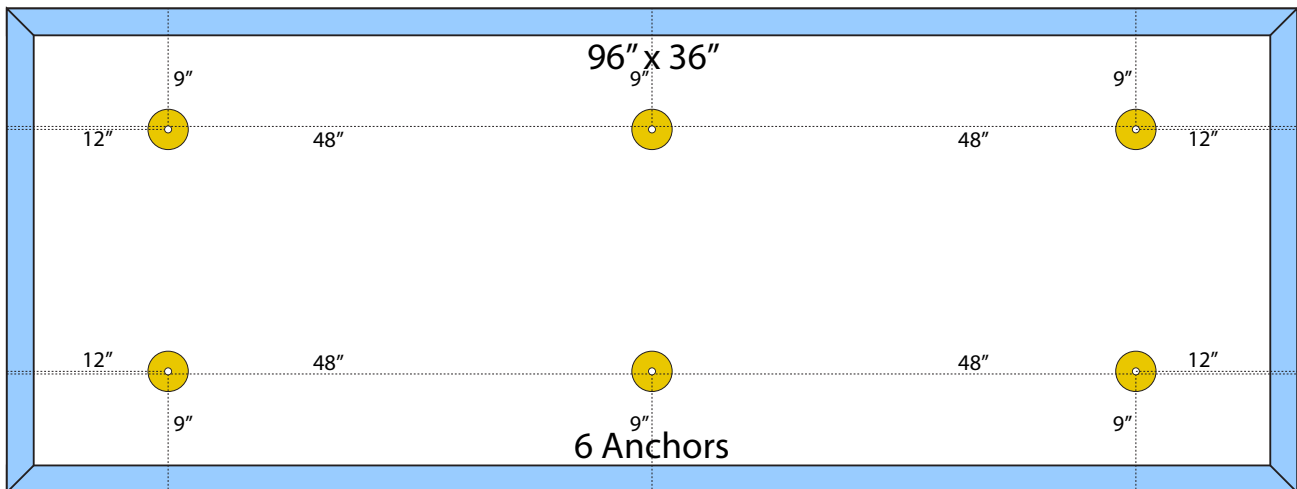
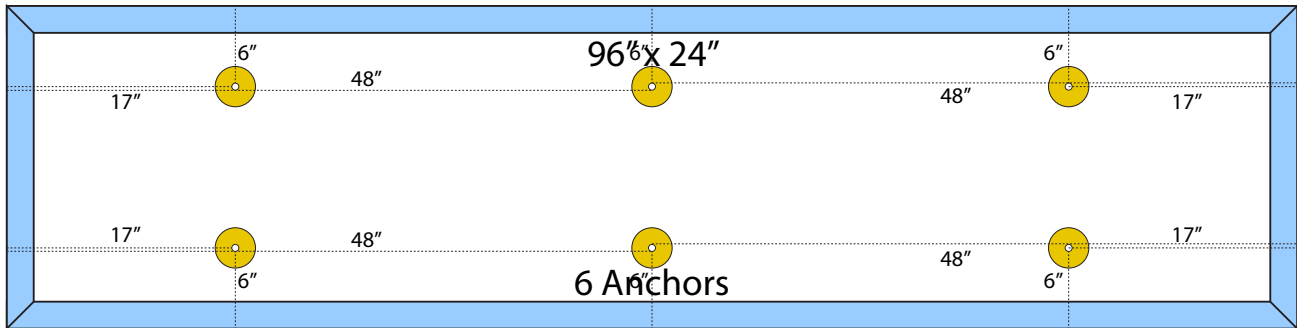

## Appendix A: Fiberglass and Polyester Rotofast Anchor Locations

